



# SS982HP

**SAFARI ARMAX SNORKEL**  
**Ford PX-I & PX-II Ranger (All Models)**  
**2.2L & 3.2L TDCi Diesel (P4AT & P5AT Engines)**



01/07/2017

## Parts List

ITEM	PART NO.	DESCRIPTION	QTY
1	680-133-600	BODY - SNORKEL (SS982HP)	1
2	000-135-950	4" AIR RAM ASSEMBLY	1
3	680-032-600	BRACKET - UPPER MOUNTING	1
4	000-002-100	BOLT - HEX - 6mm x 1.0 x 14mm (SEMS)	2
5	000-951	SCREW - S/T - 4.2mm x 13mm - S/S	3
6	000-960	INSERT - PLASTIC	3
7	000-110	STUD - 8mm x 1.25 x 25mm - S/S	6
8	000-311-300	WASHER - BODY - 8mm x 30mm - S/S	6
9	000-205-300	NUT - NYLOC - 8mm x 1.25mm - S/S	6
10	680-024-600	HOSE - AIR ENTRY	1
11	680-025-600	PLATE - HOSE SUPPORT - (Front) - S/S	1
12	680-025-625	PLATE - HOSE SUPPORT - (Main) - S/S	1
13	680-025-650	PLATE - HOSE SUPPORT - (Lower) - S/S	1
14	000-958-150	POP RIVET - 4.0mm x 13mm	12
15	000-300-350	WASHER - BODY - 4.0mm x 12mm - S/S	6
16	000-1911	CLAMP - HOSE - 100/120mm - S/S	1

17	680-967-600	PLATE - INNER GUARD SUPPORT - S/S	1
18	000-1020-300	BOLT - B/H CAP SCREW - 5.0mm x 0.8 x 12mm - S/S	10
19	000-320-350	WASHER - BODY - 5.0mm x 15mm - S/S	10
20	000-221-300	NUT - NYLOC - 5.0mm x 0.8mm - S/S	10
21	000-038-300	BOLT - B/H CAP SCREW - 6.0mm x 1.0 x 12mm - S/S	1
22	000-353	WASHER - BODY - 6.0mm x 18mm - S/S	1
23	000-204	NUT - NYLOC - 6.0mm x 1.0mm - S/S	1
24	000-1931/B	CLAMP - HOSE - SIZE 64 (BLACK)	1
25	680-217-600	TEMPLATE - AIR CLEANER HOUSING (Main)	1
26	680-217-625	TEMPLATE - AIR CLEANER HOUSING (Side)	1
27	680-017-600	TEMPLATE - GUARD PANEL (PX-II)	1
28	680-017-700	TEMPLATE - GUARD PANEL (PX-I)	1



# SS982HP

SAFARI ARMAX SNORKEL  
Ford PX-I & PX-II Ranger (All Models)  
2.2L & 3.2L TDCi Diesel (P4AT & P5AT Engines)

## Installation Guide

### Fitment to:

- Right Hand Side

### Fitting Time:

- 210min

### Special Tools:

- Body Saw (Reciprocating)
- Step Drill
- 90 degree Drill
- 4.0, 5.5, 6.0 & 6.5mm Drill bits
- Files
- Masking Tape
- Loctite 243 (thread lock)
- Touch-up paint
- Sikaflex 227 Adhesive Sealant

**Prior to commencing the installation, it is the installer's responsibility to verify that all components and particularly the template (Item 27 / 28) are correct.**

1

Remove the following in accordance with the factory service manual:

- RHS Mud Flap
- RHS Guard Liner
- RHS Guard Insulator
- Air Cleaner Assembly

2

Remove and discard:

- Air intake duct



**PX-I Guard Panel Template:**

Remove and discard the three perforated sections from the guard panel template (item 28) as shown.

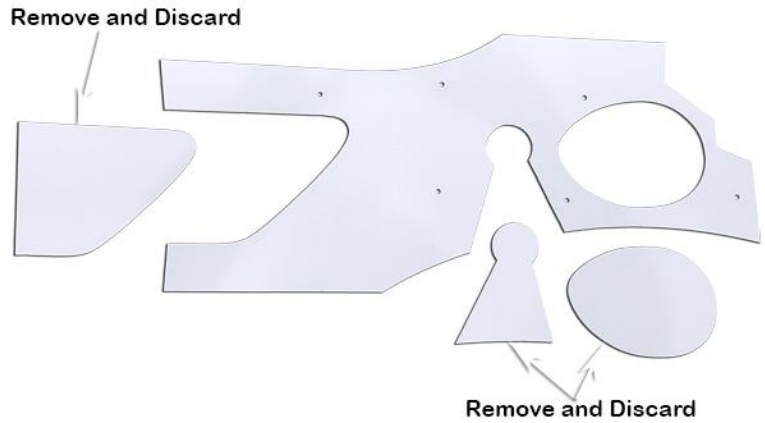

**PX-II Guard Panel Template:**

Remove and discard the three perforated sections from the guard panel template (item 27) as shown.

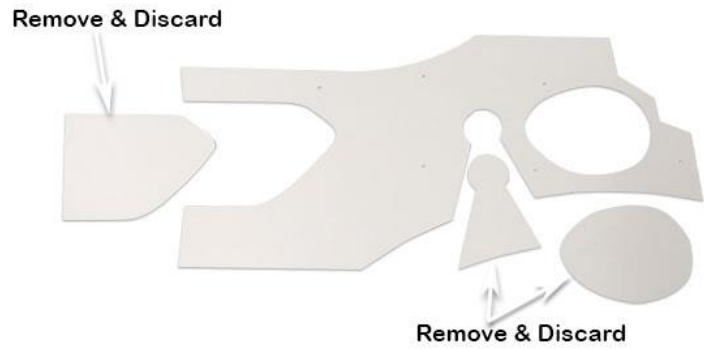

4a

**PX-I Guard Panel Template fitment:**

Align the guard panel template (Item 28) with the upper and rear edges of the RHS guard panel as shown.

Tape the template to the guard panel with masking tape.

Mark all hole positions and the cut-out section with a felt tip pen.

Remove the template.

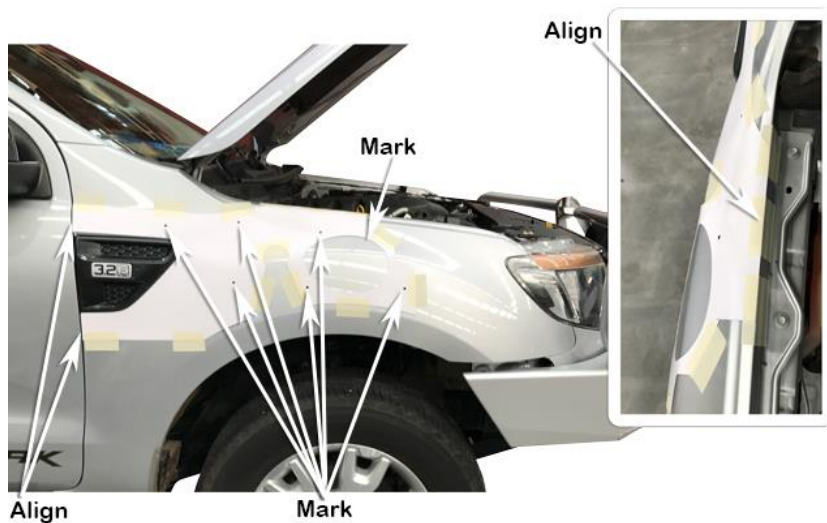

4b

**PX-II Guard Panel Template fitment:**

Align the guard panel template (Item 27) with the upper and rear edges of the RHS guard panel as shown.

Tape the template to the guard panel with masking tape.

Mark all hole positions and the cut-out section with a felt tip pen.

Remove the template.



Drill a pilot hole for each of the marked hole positions.

Use a step drill to drill the six mounting holes to 16mm diameter.

Drill 2 or 3, 10mm diameter holes in the cut-out section for a start/stop point for the body saw, using the body saw cut the main hole in the guard panel as marked from the template cut-out in step 4.

Deburr and paint all holes.

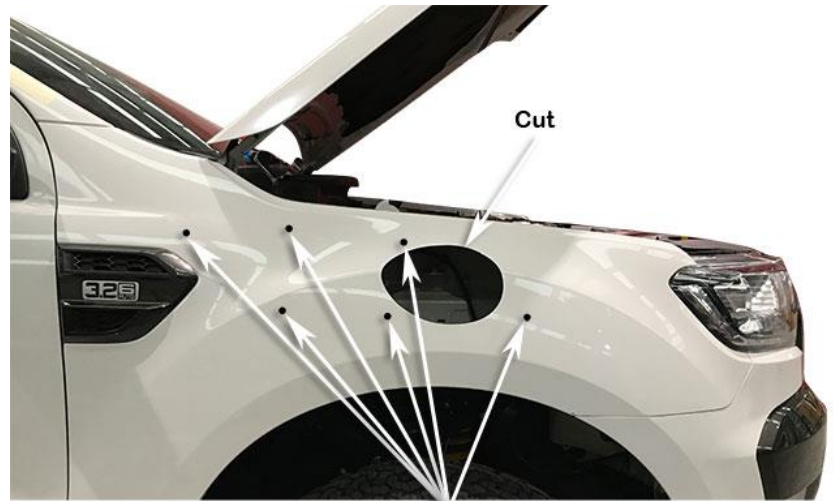

Step Drill 16mm Dia.

Install the upper mounting bracket (Item 3) to the snorkel body (Item 1) with hex bolts (Item 4).

Apply Loctite 243 to each of the stainless steel mounting studs (Item 7) and install the studs finger tight into the snorkel body (Item 1) mounting inserts as shown.

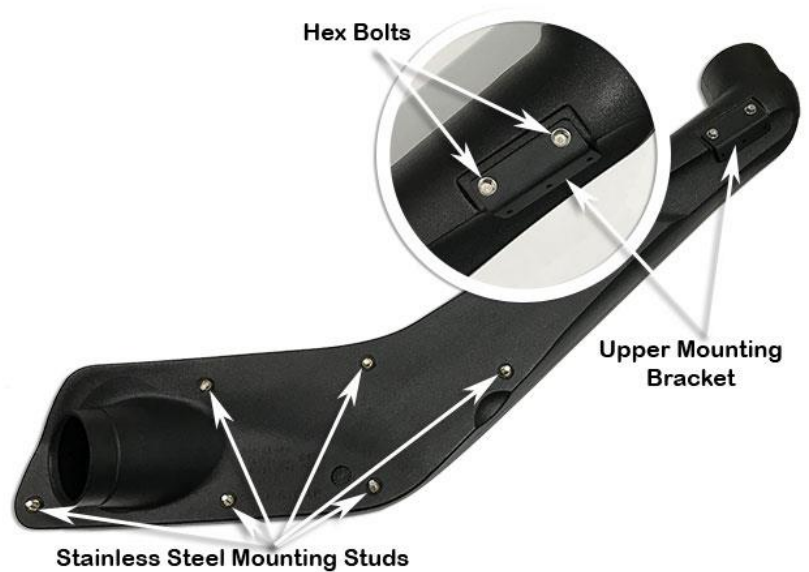

7

Place a strip of masking tape along the A-pillar panel.

Carefully install the snorkel body (Item 1) to the guard panel.

With the snorkel body correctly positioned, mark the outline of the upper mounting bracket (Item 3) onto the masking tape.



8

Remove the snorkel body (Item 1) from the vehicle and remove the upper mounting bracket (Item 3) from the snorkel body.

Position the upper mounting bracket (Item 3) onto the A-pillar and align the bracket with the marked bracket outline. Mark the three mounting hole positions with a felt tip pen.

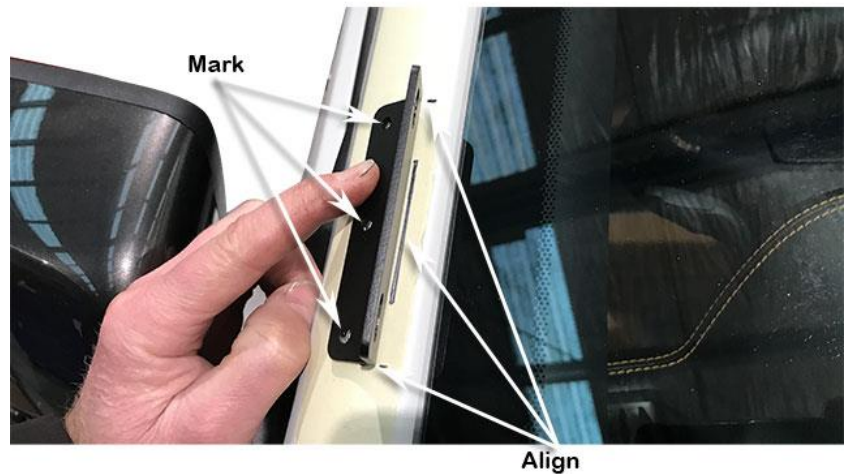

9

Drill a pilot hole at each of the three marked hole positions. Drill each hole position to 8mm diameter with a step drill or 8mm drill bit.

Deburr and paint holes to prevent rust.

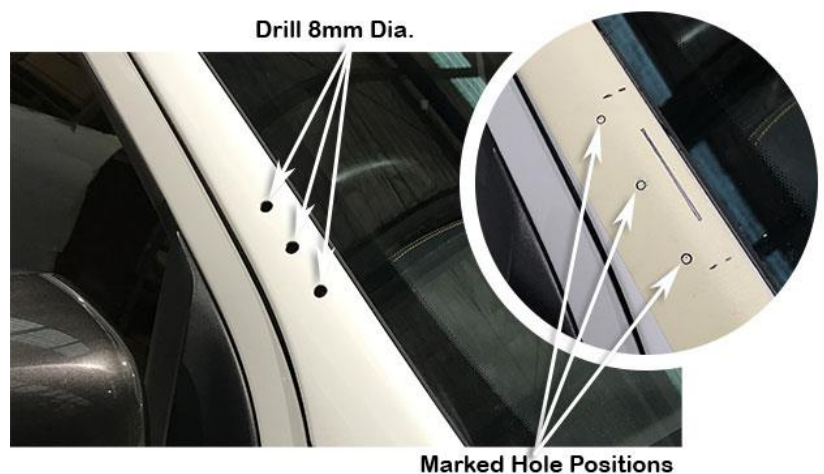

Install the plastic inserts (Item 6) into the 8mm diameter holes in the A-pillar.

Secure the upper mounting bracket (Item 3) to the A-pillar with three self-tapping screws (Item 5).



Mark the centres of the two spot welds holding the bracket shown to the inner guard panel, using a 6.5mm drill bit and a 90 degree drill, drill out the two spot welds.

Using a small screwdriver or pry bar remove the bracket.

Unclip the washer hose from the inner guard panel.

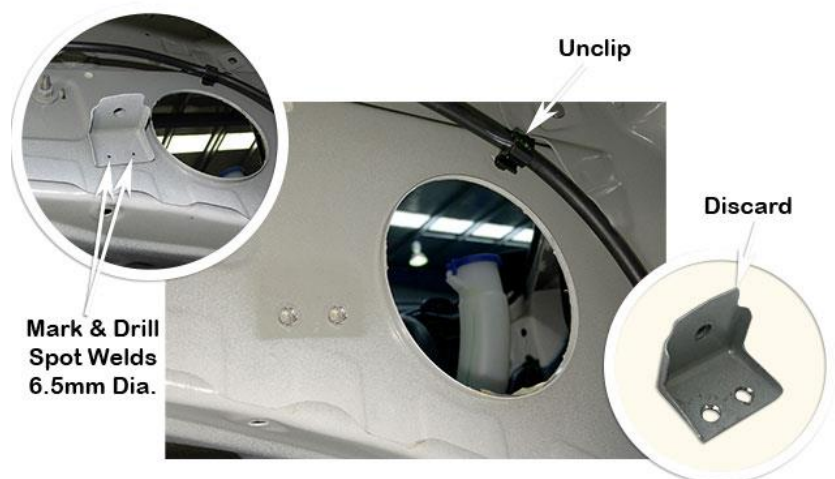



Unclip the wiring loom from its mounting positions.

Install the inner guard support plate (item 17) to the inner guard panel, align and fasten to the 6.0mm hole in the inner guard panel with a M6 x 12mm button head bolt (item 21), M6 body washer (item 22) and M6 nyloc nut (item 23), align the support plate to the fold in the inner guard panel, mark or drill all ten mounting hole positions with a 5.5mm drill bit, mark or drill the washer hose relocation hole with a 6.0mm drill bit.

Mark the inner guard panel cut-out with a felt tip pen.

Remove the inner guard support plate (item 17).

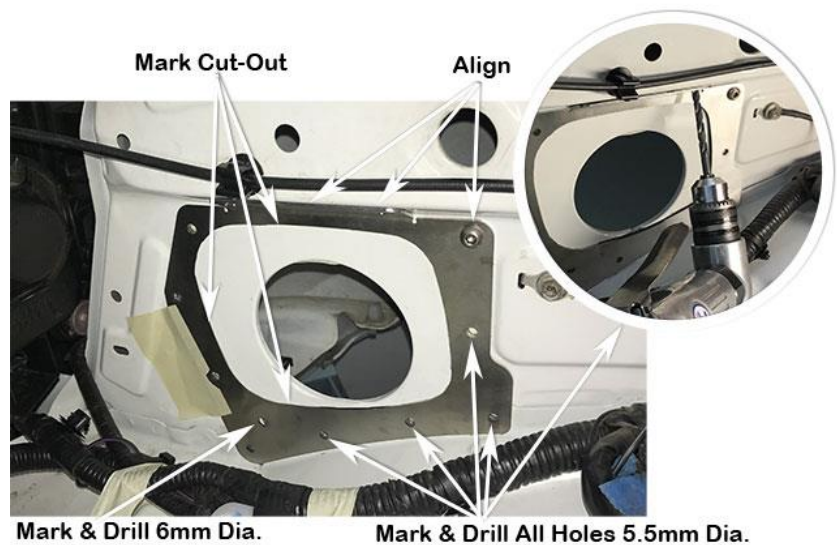

Using the body saw, cut the marked cut-out in the inner guard panel, cutting on the outside of the line.

Deburr and paint all holes and cut section of panel to prevent rust.

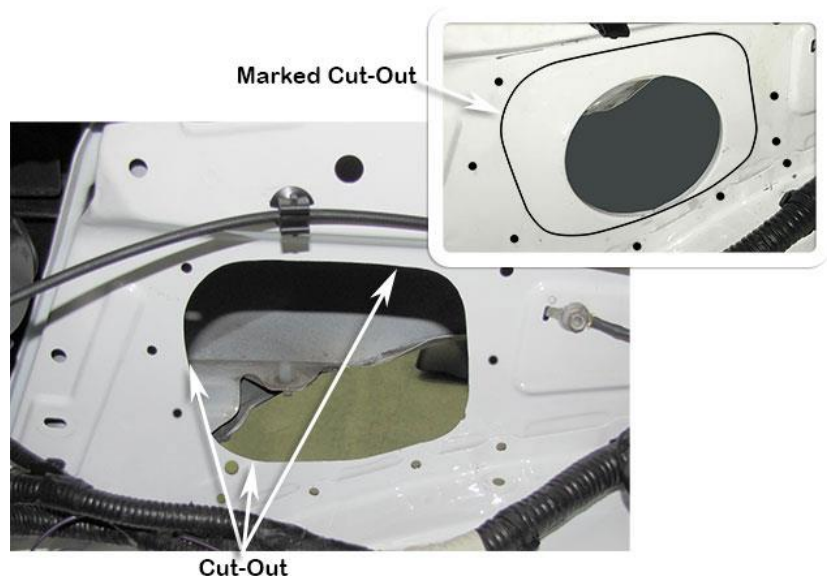

Apply Sikaflex adhesive sealant to the inner guard support plate (item 17) and install the support plate to the inner guard panel, install all ten M5 x 12mm button head bolts (item 18), M5 body washers (item 19) and M5 nyloc nuts (item 20), install the M6 x 12mm button head bolt (item 21), M6 body washer (item 22) and M6 nyloc nut (item 23).

With all fasteners installed, secure the inner guard support plate to the inner guard panel.

Clean-up any excess adhesive sealant to ensure a neat finish.

Clip the wiring loom into the standard mounting holes.

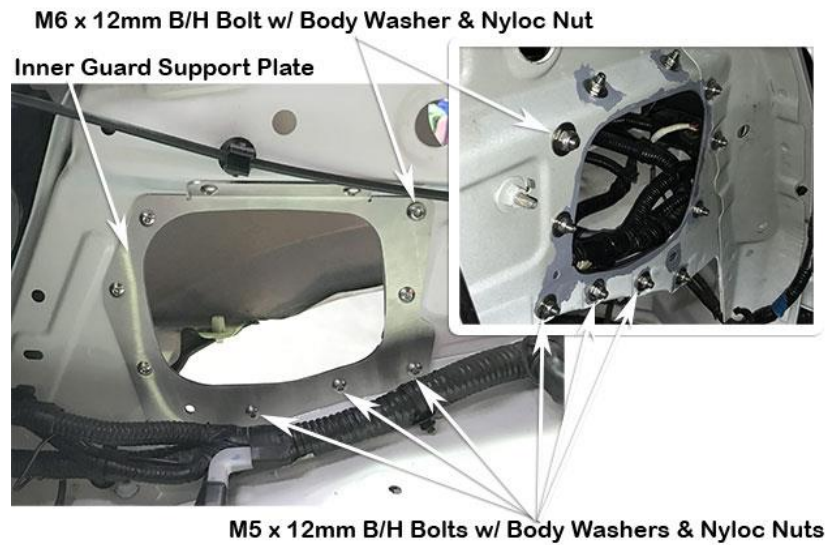

Remove and discard the air cleaner base inlet adaptor from the air cleaner base.



Mark a cutting line around the air cleaner base inlet snout with a paint marker as shown.



17

Using the body saw, carefully cut-off the air cleaner base inlet snout flush with the air cleaner base housing.



18

Using a grinder, carefully grind off the air cleaner base drain flush with the air cleaner base housing.

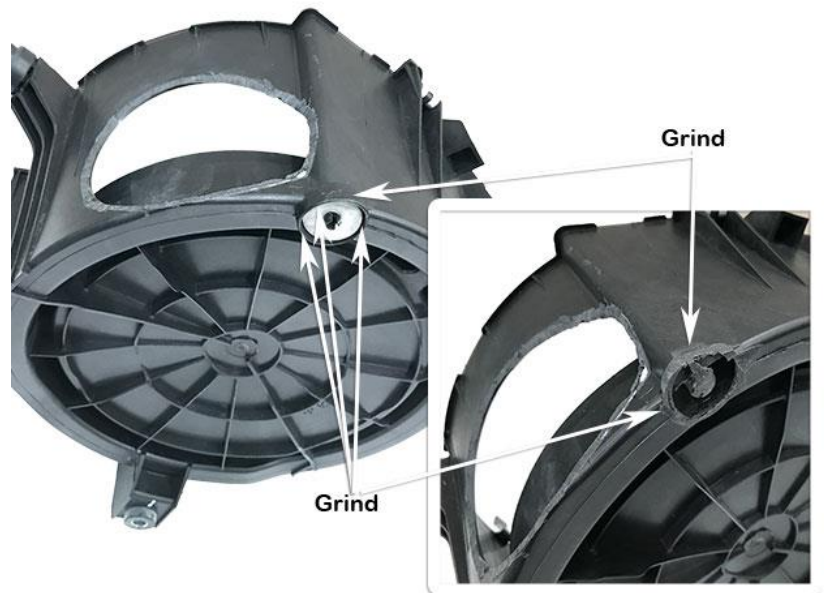

19

Using a sharp knife or grinder shortened the three ribs above the air cleaner inlet hole to 13mm in length as shown.

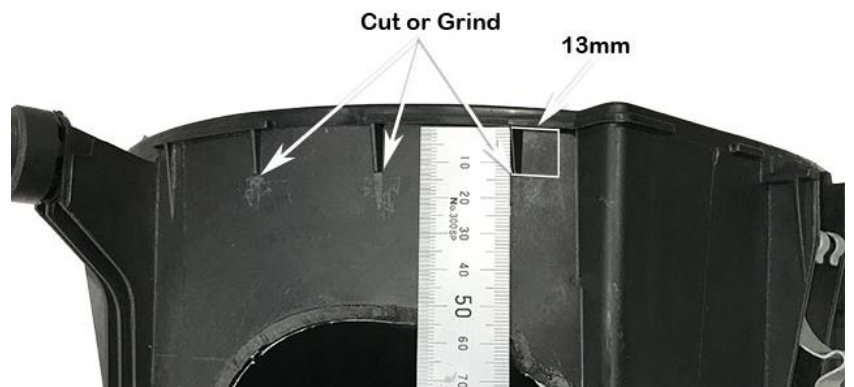

Align the air cleaner housing template (item 25) to the three positions on the air cleaner base as shown.

Mark the cut-out section and the five hole positions with a paint marker pen.

Remove the template.

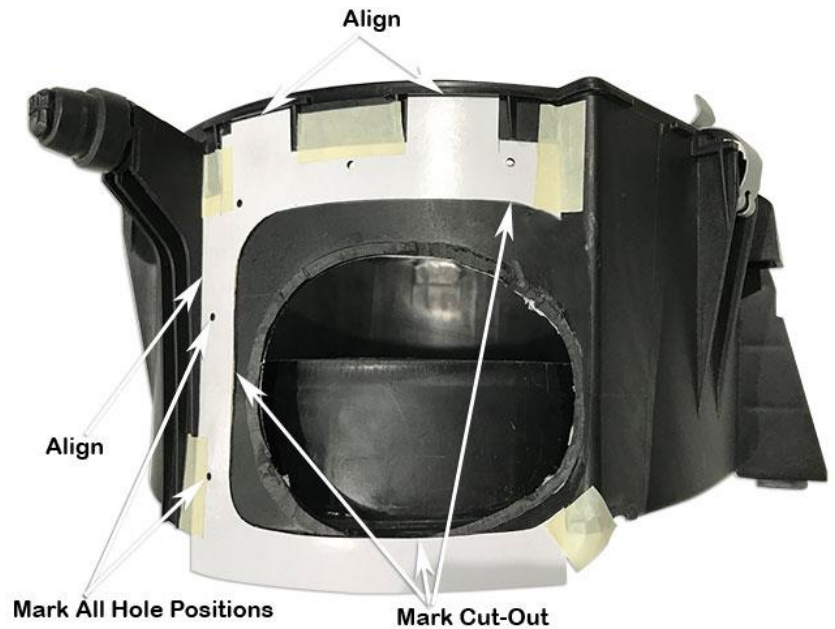

Align the air cleaner housing template (item 26) to the three positions on the air cleaner base as shown.

Mark the cut-out section and the three hole positions with a paint marker pen.

Remove the template.

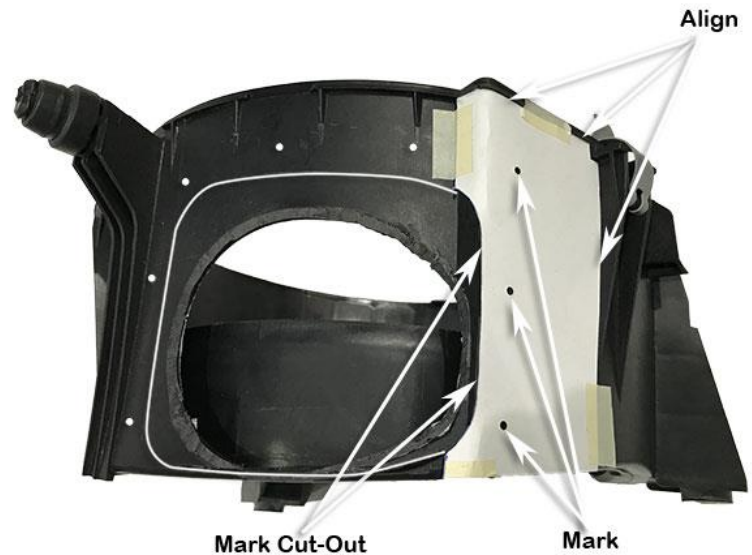

Using a 4.0mm drill bit, drill all eight marked hole positions.

Using the body saw cut the new air inlet hole as marked from the templates in steps 20 & 21.

Use a file to clean-up the cut section, deburr all drilled holes.

**Caution: Extreme care must be taken when drilling and cutting the new air inlet hole in the air cleaner base.**

**DO NOT cut through the internal wall of the air cleaner base.**



Install the air entry hose (item 10) onto the air cleaner base, loosely install pop rivets (item 14) to locate and align the hose onto the air cleaner base.

With the hose correctly positioned drill the four lower mounting hole positions using a 4.0mm drill bit.

Remove the pop rivets and air entry hose.

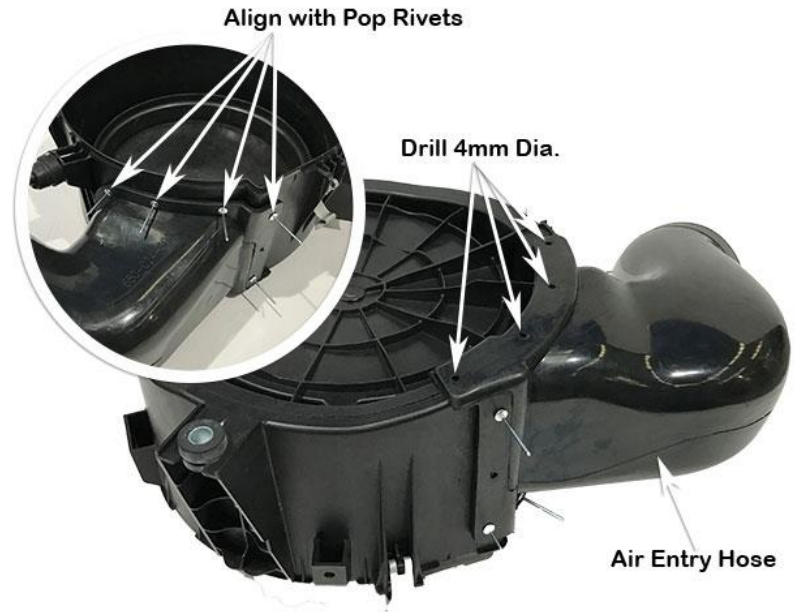

Bend the hose support plate (item 12) to the shape of the air cleaner base as shown.

**Note: The orientation of the hose support plate prior to bending (4.3mm dia. hole closest to the end side).**

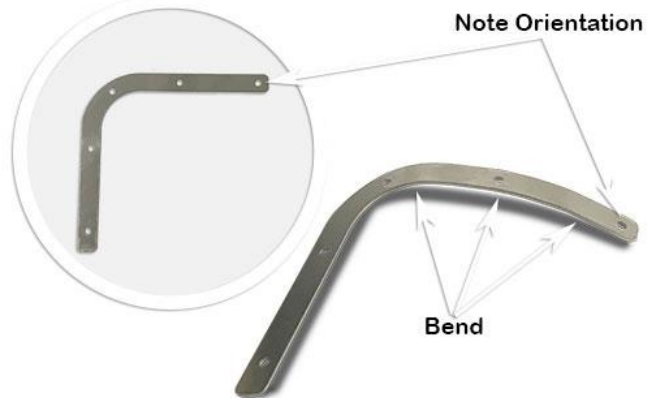

Apply Sikaflex adhesive sealant to the mating surfaces of the air entry hose.

Install the air entry hose (item 10) onto the air cleaner base, install the main, front and lower clamping plates (item's 11, 12, & 13) to the hose, install all twelve pop rivets (item 14), install a 4mm body washer (item 15) to the six lower pop rivets as shown.

**Note: The orientation of the six lower pop rivets.**

With all twelve pop rivets install, use the pop rivet gun to secure all pop rivets.

Clean-up any excess sealant to ensure a neat finish.



The end of the air entry hose (item 10) must be squashed inwards and taped to hold in two positions as shown.

**N.B: it is critical the hose is taped the way shown in the photo, for installation purposes.**

With the hose taped, spray lubricant over the outside of the hose.

Install the air cleaner base into position, guiding the air entry hose through the hole in the inner guard panel, with the air cleaner base correctly installed fasten with the two standard mounting bolts.

Remove the tape.



Loosely install the 100/120mm hose clamp (Item 16) onto the air entry hose (item 10).



Carefully install the snorkel body (Item 1) to the guard panel, guiding the snorkel body outlet into the air entry hose (item 10), align the snorkel body to guard panel and upper mounting bracket.

When correctly aligned, fasten the snorkel body to the guard panel with body washers (Item 8) and nyloc nuts (Item 9).

Fasten the snorkel body to the upper mounting bracket with hex bolts (Item 4).

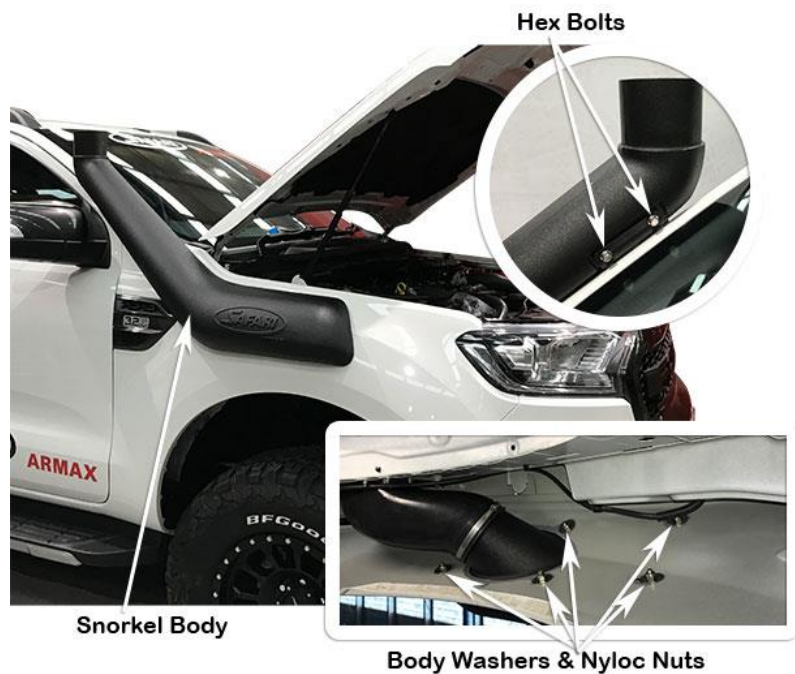

Ensure the air entry hose is correctly installed onto the snorkel body outlet and tighten the 100/120mm hose clamp (item 16).

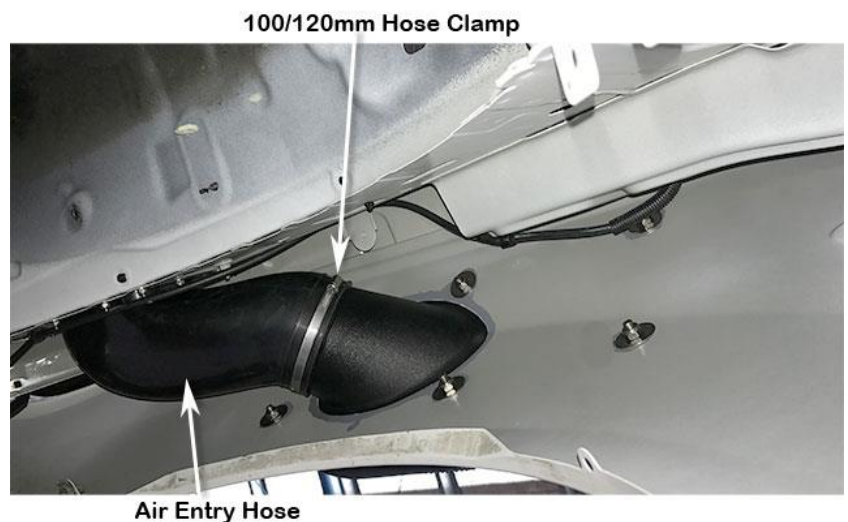

30

Relocate the washer hose mounting clip into the 6.0mm hole drilled in the inner guard panel in step 12.



Relocate

31

Install the black hose clamp (Item 24) loosely over the base of the air ram assembly (Item 2).

Install the air ram assembly onto the snorkel body.

Align the air ram assembly and tighten the black hose clamp (Item 24).



32

Install the RHS guard insulator, guard liner, mud flap, air cleaner element, air cleaner lid, reconnect sensor wiring and any other items that may have been removed during the snorkel installation process.

33

**N.B: It is the installer's responsibility to ensure that all connections are water tight.**